



How to Setup GPSTab

With an IOSix ELD

BEFORE YOU BEGIN

First you need to create an admin account and then give the access to the driver by creating a separate account for the driver's ELD application.

Contents

- 3** Set up your Admin Account
- 9** Add ELDs to GPSTab
- 13** Add Vehicles to GPSTab
- 18** Add Drivers to GPSTab
- 24** Install your ELD



Set up your Admin Account

Step 1: Click Either of These Buttons to Begin



[Home](#) [Products](#) [Support](#) [Store](#) [Blog](#) [Contact Us](#)

[→ Sign in](#)

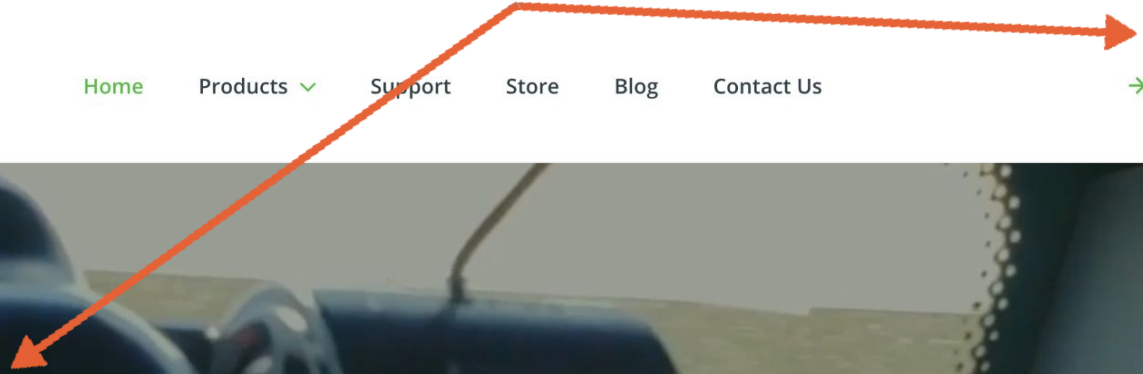

**A comprehensive suite of tools
to manage your fleet.**

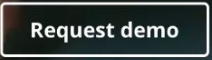

Step 2: Enter Your Name and Email Address

When first establishing a GPSTab account you will start with the **Admin account** (which will need to be a different email from the driver account.)

Use your **Admin** email address for this part.

You'll add a Driver email address later.

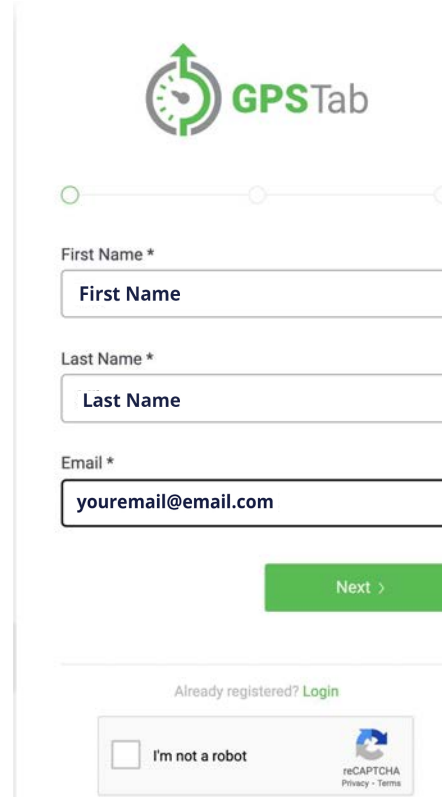

The screenshot shows the registration page for GPSTab. At the top is the GPSTab logo, which consists of a green circular icon with a clock face and an upward-pointing arrow, followed by the text "GPSTab". Below the logo is a progress indicator with three circles, the first of which is filled. The form contains three input fields: "First Name *" with the placeholder text "First Name", "Last Name *" with the placeholder text "Last Name", and "Email *" with the placeholder text "youremail@email.com". A green "Next >" button is positioned below the email field. At the bottom of the form, there is a link "Already registered? Login" and a reCAPTCHA widget with the text "I'm not a robot" and the reCAPTCHA logo.

Step 3: Enter Your Company Info



Company Name *

USDOT *

Time Zone *

< Back

Next >

Already registered? [Login](#)

I'm not a robot



Step 4: Create A Password And Register

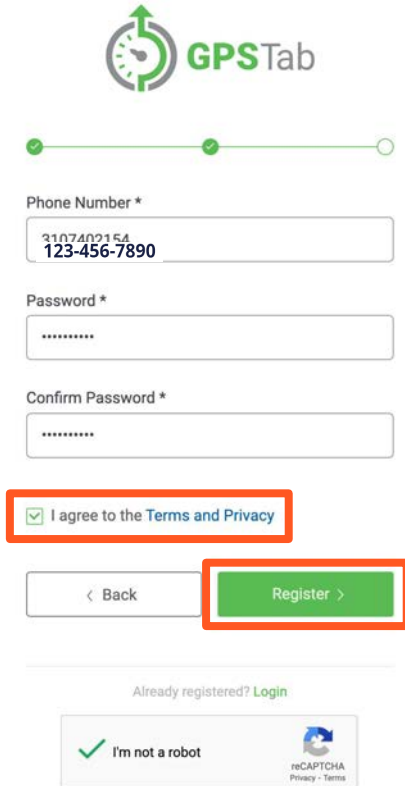

The screenshot shows the registration form for GPSTab. At the top left is the GPSTab logo, which consists of a green clock face with an upward-pointing arrow and the text "GPSTab" in green. Below the logo is a progress indicator with three circles, the second of which is filled. The form fields are: "Phone Number *" with the value "3107402154" and "123-456-7890"; "Password *" with masked characters "*****"; and "Confirm Password *" with masked characters "*****". Below these is a checkbox labeled "I agree to the Terms and Privacy" which is checked. At the bottom are a "< Back" button and a green "Register >" button. At the very bottom, there is a link "Already registered? Login" and a reCAPTCHA widget with the text "I'm not a robot" and the reCAPTCHA logo.



Email has been sent

Confirmation email has been sent to **youremail@email.com** Please check for an email from GPSTab and click on the included link to activate your account.

Step 5: Confirm Your Email Address

Please confirm your email address  Inbox x



Utech Team <no-reply@gpstab.com>

to me ▾

Fri, Jan 7, 10:59 AM (3 days ago)



EMAIL ADDRESS CONFIRMATION

Dear **User Name**

Please confirm your email address by clicking the link below.

[CONFIRM E-MAIL ADDRESS](#)

If you received this by mistake or weren't expecting it, please disregard this email.

– Utech ELD Team

 Reply

 Forward



Add ELDs to GPSTab

Step 6: Click ELD to show options, then click ELDs and after that ADD ELD

Clicking ELD expands the other options

The screenshot displays the GPS Tab application interface. On the left is a green sidebar menu with the following items: UNITS (All Units, By Units, By Group, Reports) and ELD (ELD, Drivers, Logs, Driving Events, Vehicles, ELDs, ELD Groups, Transfer ELD Data). The 'ELD' item in the sidebar is highlighted with a red box. The main content area shows the 'ELDs' page with a search bar and an 'ADD ELD' button highlighted with a red box. Below the search bar is a table with columns for 'Serial No ^' and 'Notes', and an 'Edit / Delete' button. The table currently contains no data, indicated by 'no ELDs'.

Step 7: Enter The Serial Number From The ELD

The IOSix serial number and firmware will be printed on a sticker inside the box.



A screenshot of the GPSTab mobile application interface. The app has a green sidebar menu on the left with options like 'All Units', 'By Units', 'By Group', 'Reports', 'ELD', 'Drivers', 'Logs', 'Driving Events', 'Vehicles', 'ELDs', 'ELD Groups', and 'Transfer ELD Data'. The main content area shows the 'Home / ELDs / E0E:XXXXXXXX' path. The serial number 'E0E:XXXXXXXX' is displayed in large text and also entered into a 'Serial No' input field. Below the input field, there is a 'Notes' section with the text 'New BlueLink with new firmware and light duty settings'. At the bottom right, there are 'CANCEL' and 'OK' buttons, with the 'OK' button highlighted by a red box.

Step 8: You Should Now See Your ELD Listed

The screenshot shows the 'GPS Tab' application interface. On the left is a green sidebar with navigation options: UNITS (All Units, By Units, By Group, Reports) and ELD (ELD, Drivers, Logs, Driving Events, Vehicles, ELDs, ELD Groups, Transfer ELD Data). The main content area is titled 'ELDs' and shows a table with one entry. The table has columns for 'Serial No' and 'Notes'. The entry has the serial number 'E0E:XXXXXXXX' and the note 'New BlueLink with new firmware and light duty settings'. There is a search bar, an 'ADD ELD' button, and 'Edit / Delete' options for the entry. The page also shows 'Showing 1 to 1 of 1 entries' and a pagination control.

GPS Tab

Home / ELDs

ELDs

ELDS [ADD ELD](#)

| Serial No ^ | Notes | Edit / Delete |
|--------------|--|-------------------------------------|
| E0E:XXXXXXXX | New BlueLink with new firmware and light duty settings | ✎ ✖ |

Showing 1 to 1 of 1 entries

Navigation: < 1 >



Add Vehicles to GPSTab

Step 9: Click ELD, then Vehicles and ADD Vehicle

The screenshot displays the GPS Tab application interface. On the left is a green sidebar with a menu. The 'Vehicles' menu item at the bottom of the sidebar is highlighted with a red box. The main content area shows the 'Vehicles' page. At the top right of the main area, the 'ADD VEHICLE' button is highlighted with a red box. Below the button is a search bar and a table with columns: Vehicle ID, Make / Model, License Plate No, ELD No, Telematics, Device Version, Notes, Status, and Edit / Deactivate. The table currently contains the text 'no vehicles'.

GPS Tab

Home / Vehicles

Vehicles

VEHICLES

[ADD VEHICLE](#)

| Vehicle ID | Make / Model | License Plate No | ELD No | Telematics | Device Version | Notes | Status | Edit / Deactivate |
|-------------|--------------|------------------|--------|------------|----------------|-------|--------|-------------------|
| no vehicles | | | | | | | | |

14

Step 10: Add Your Vehicle Info

Vehicle ID is
your Truck
Number

The screenshot shows the 'New Vehicle' form in the GPSTab application. The form is titled 'NEW VEHICLE' and contains the following fields:

- Vehicle ID ***: Truck 123
- Make**: Volvo
- Model**: VNL 760
- Year**: [Dropdown menu]
- License Plate No**: XXX XXX
- License Plate Issuing State**: [Dropdown menu]

At the bottom of the form, there is a checkbox labeled 'Enter VIN manually' which is checked.

The left sidebar of the application is visible, showing the following menu items:

- UNITS
 - All Units
 - By Units >
 - By Group >
 - Reports
- ELD
 - ELD
- Drivers
- Logs
- Driving Events
- Vehicles
- ELDs
- ELD Groups
- Transfer ELD Data

The bottom of the sidebar is labeled 'DISPATCH BOARD'.

Step 11: Finish Adding Your Vehicle Info

Your ELD is now available to select from the "ELD No." drop-down menu.

The screenshot shows the GPS Tab mobile application interface. On the left is a green sidebar menu with options: Logs, Driving Events, Vehicles, ELDs, ELD Groups, Transfer ELD Data, DISPATCH BOARD (Dispatch Board), EDIT (Units, Groups), and SETTINGS (Settings). The main screen displays a form for adding vehicle information. The form fields are: Year (2017), License Plate No (U025UC XXX XXX), License Plate Issuing State (UT), Enter VIN manually (checked), VIN (KMBJ33A45HU468661XXXXXXXXXXXXXXXX), Fuel Type (Gasoline), and ELD No (EOE:XXXXXXXXXX). The ELD No field is highlighted with a red box. At the bottom right, there are CANCEL and OK buttons, with the OK button also highlighted by a red box. The URL https://app.gpstab.com is visible at the bottom left of the screen.

Step 12: You Should Now See Your Vehicle Listed

Your ELD is now assigned to your vehicle

The screenshot displays the GPSTab interface for the 'Vehicles' section. The left sidebar contains navigation options for 'UNITS' (All Units, By Units, By Group, Reports) and 'ELD' (ELD, Drivers, Logs, Driving Events, Vehicles, ELDs, ELD Groups, Transfer ELD Data). The main content area shows a table of vehicles with the following columns: Vehicle ID, Make / Model, License Plate No, ELD No, Telematics, Device Version, Notes, Status, and Edit / Deactivate. A single vehicle entry is shown: 'Truck 123' with 'Volvo / Truck 123' as the make/model, 'xxx xxx' as the license plate, and 'E0E:XXXXXXXX' as the ELD ID. The 'ELD No' column for this entry is highlighted with a red box. The status is 'active'. A search bar and an 'ADD VEHICLE' button are located at the top right of the table area. The page indicates 'Showing 1 to 1 of 1 entries' and includes pagination controls.

| Vehicle ID | Make / Model | License Plate No | ELD No | Telematics | Device Version | Notes | Status | Edit / Deactivate |
|------------|-------------------|------------------|--------------|------------|----------------|-------|--------|-------------------|
| Truck 123 | Volvo / Truck 123 | xxx xxx | E0E:XXXXXXXX | | | | active | |



Add Drivers to GPSTab

Step 13: Click ELD, then click Drivers and ADD driver

The screenshot displays the GPSTab application interface. On the left is a green sidebar with navigation options. The main content area shows the 'Drivers' page with a table and an 'ADD DRIVER' button highlighted in red.

GPSTab

Home / Drivers

Drivers

REPORT

DRIVERS

Search...

ADD DRIVER

| First Name | Last Name | Driver ID | Username | Co-Driver | Vehicle ID | Notes | Activated | Terminated | App Version | Device Version | ELD |
|------------|-----------|-----------|----------|-----------|------------|-------|-----------|------------|-------------|----------------|-----|
| no drivers | | | | | | | | | | | |

ELD

- ELD
- Drivers**
- Logs
- Driving Events
- Vehicles
- ELDs
- ELD Groups
- Transfer ELD Data

<https://app.gpstab.com>

Step 14: Add Your Driver Info

Driver email must be unique.

You can also generate a password for the driver's ELD application.

The screenshot shows the 'New Driver' form in the GPS Tab application. The form is titled 'NEW DRIVER' and contains the following fields:

- First Name***: First Name
- Last Name***: Last Name
- Driver ID***: 1
- Username***: User Name
- Password***: XXXXXX. A green 'GENERATE' button is highlighted with a red box.
- Email***: youremail@email.com
- Phone No***: 123-456-7890

The sidebar on the left includes the following sections:

- UNITS**: All Units, By Units, By Group, Reports
- ELD**: ELD (selected)
- Drivers**: Drivers, Logs, Driving Events, Vehicles, ELDs, ELD Groups, Transfer ELD Data
- DISPATCH BOARD**

Step 15: Keep Adding Your Driver Info

Your Vehicle is now available to select from the Vehicle ID drop-down menu.

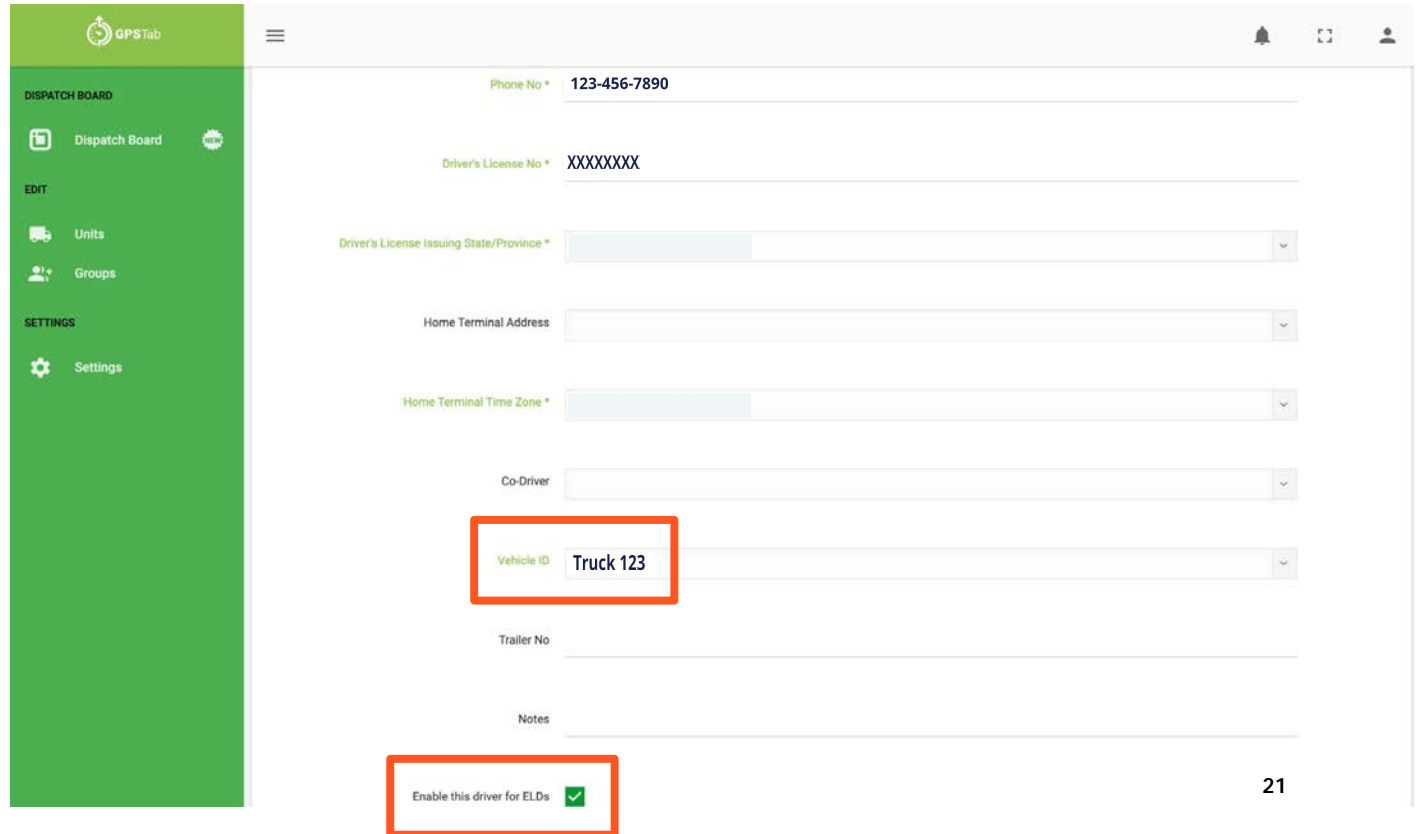

The screenshot shows a web interface for adding driver information. On the left is a green sidebar with the 'GPS Tab' logo and navigation options: 'DISPATCH BOARD' (Dispatch Board), 'EDIT' (Units, Groups), and 'SETTINGS' (Settings). The main form contains the following fields:

- Phone No * 123-456-7890
- Driver's License No * XXXXXXXX
- Driver's License Issuing State/Province * (dropdown menu)
- Home Terminal Address (dropdown menu)
- Home Terminal Time Zone * (dropdown menu)
- Co-Driver (dropdown menu)
- Vehicle ID Truck 123 (dropdown menu, highlighted with a red box)
- Trailer No (text input)
- Notes (text input)

At the bottom of the form, there is a checkbox labeled 'Enable this driver for ELDs' which is checked, also highlighted with a red box.

Step 16: Finish Adding Your Driver Info

This is where you enable ELD or E-log modes for your driver. Also you can activate PC or YM from here.

Please Note!

ELD Mode will be enabled for your Driver by default.

GPSTab

Co-Driver

Vehicle ID Truck 123

Trailer No

Notes

Enable this driver for ELDs

Enable this driver for E-Log

Allow Yard Move

Allow Personal Conveyance

CANCEL OK

Step 17: You Should Now See Your Driver Listed

Your vehicle is now assigned to your Driver.

The screenshot shows the GPSTab interface. On the left is a green sidebar with navigation options: UNITS (All Units, By Units, By Group, Reports), ELD (ELD), Drivers, Logs, Driving Events, Vehicles, ELDs, ELD Groups, and Transfer ELD Data. The main content area is titled 'Drivers' and contains a table of driver information. The table has columns for First Name, Last Name, Driver ID, Username, Co-Driver, Vehicle ID, Notes, Activated, Terminated, App Version, and Device Version. A single entry is shown with 'Truck 123' in the Vehicle ID column, which is highlighted with a red box. The page also includes a search bar, an 'ADD DRIVER' button, and a 'REPORT' button.

| First Name | Last Name | Driver ID | Username | Co-Driver | Vehicle ID | Notes | Activated | Terminated | App Version | Device Version |
|------------|-----------|-----------|-----------|-----------|------------|-------|-----------|------------|-------------|----------------|
| First Name | Last Name | 1 | User Name | | Truck 123 | | | | | |



Install your ELD

Step 18: Locate Your Vehicle's Diagnostic Port

ENGINE OFF

To meet the requirements of the ELD rule, the GPSTab application must be launched and the ELD device must be connected prior to starting the engine.

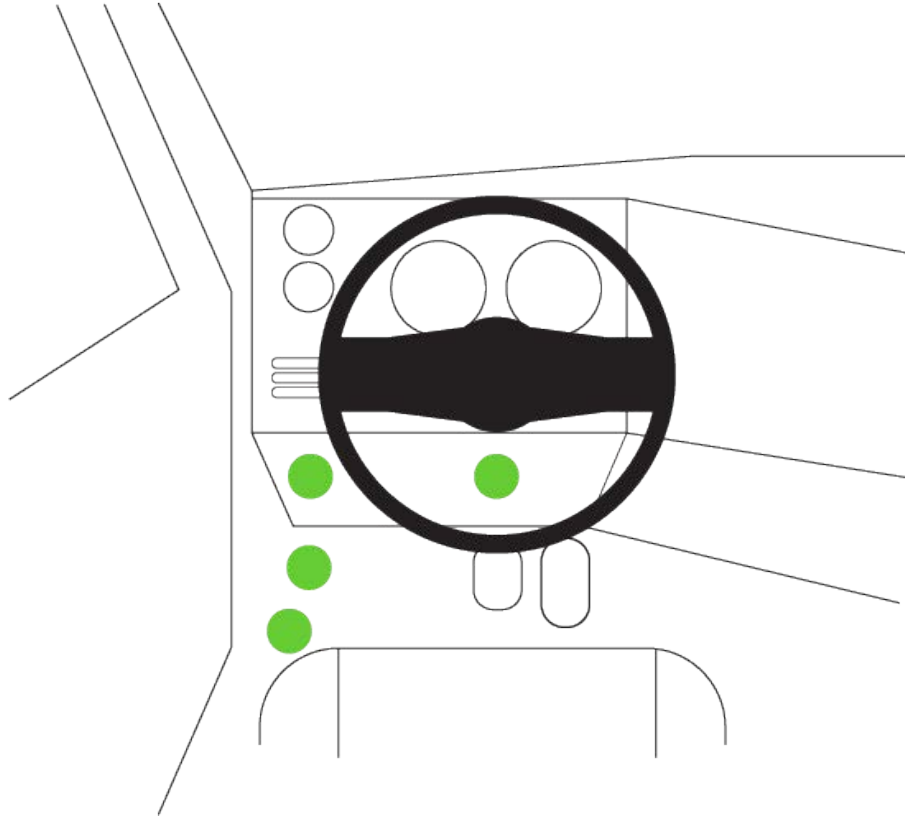

Step 19: Connect The Cable To The Port + The ELD

ENGINE OFF

You can watch an IOSix installation video here:

<https://www.youtube.com/watch?v=-TZ3RQdssgE&list=PLiQzvQxt4f5dhd-POP3XyzaybiZZTGeaj&index=1>

SCAN HERE

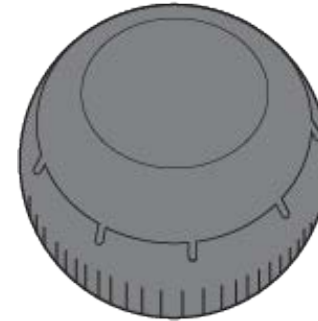
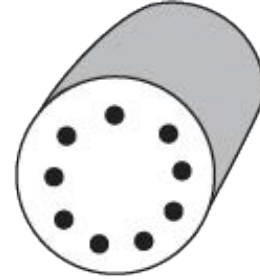
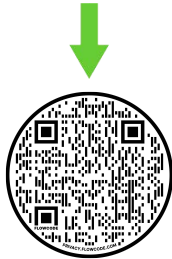

IOSix ELD connects to 9-pin connector

Step 20: Install The GPSTab App On Your Smartphone

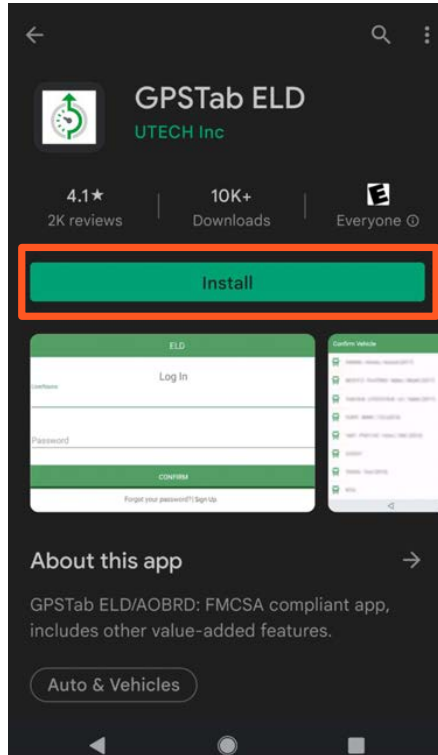

Step 21: Sign In To The GPSTab App On Your Phone

GPSTab ELD

Log In

Username
User Name  **Notice:** This is your Driver login, **NOT** Admin.

Password
.....

CONFIRM

[Forgot your password?](#) | [Sign Up](#)

[Terms and Privacy](#)

Step 22: Select Your Vehicle

← Confirm Vehicle 🔍

 Truck 123 XXX XXX Volvo / VNL 760 ✓

Step 23: You Should See This Screen

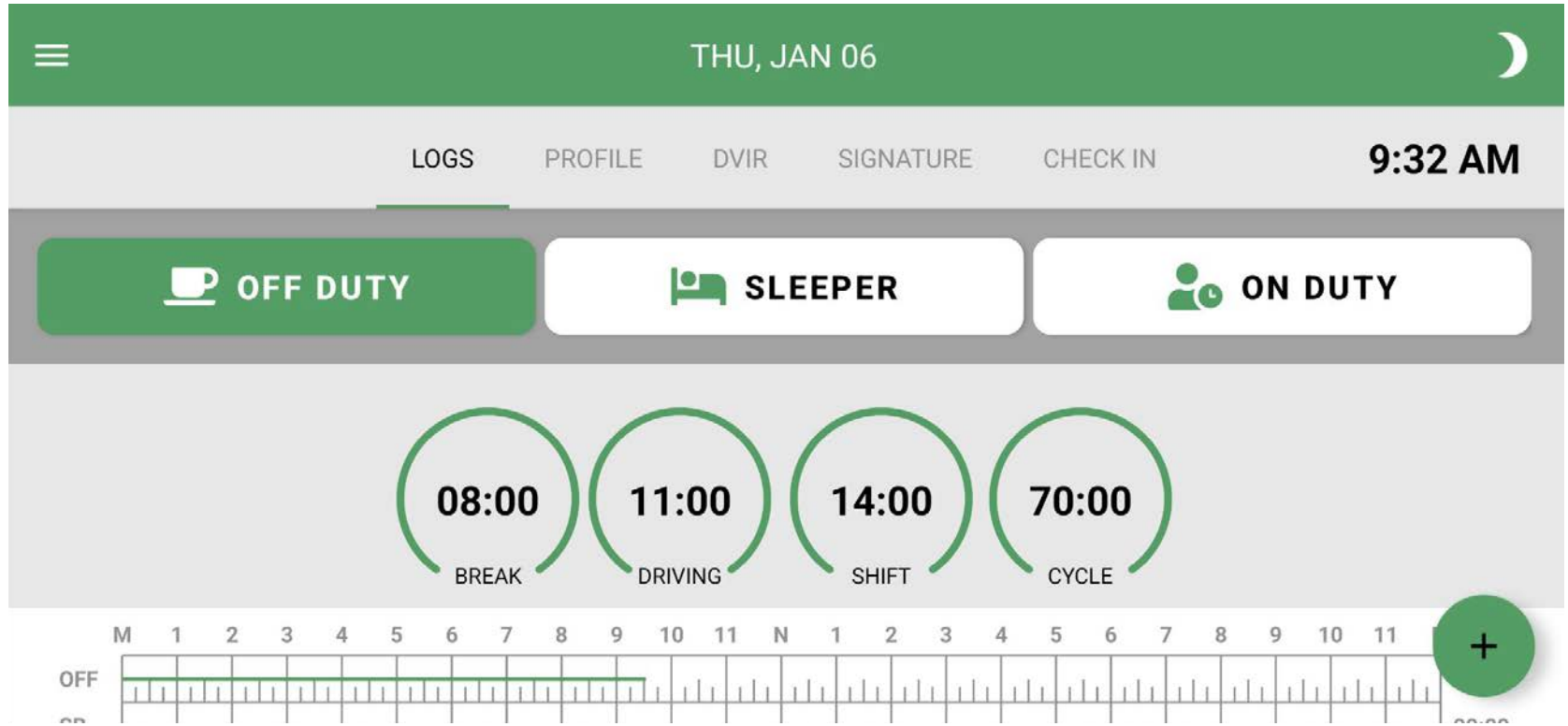



For more information please contact

Sales Team

Phone: (888) 228-4460/ext 1
Email: sales@gpstab.com

Support Team

Phone: (888) 228-4460/ext 2
Email: support@help24.us

Additional videos are available at the GPSTab Youtube channel at

https://www.youtube.com/channel/UC_Scq-p5daVZ3TorAJ5kmVw.

SCAN HERE

